

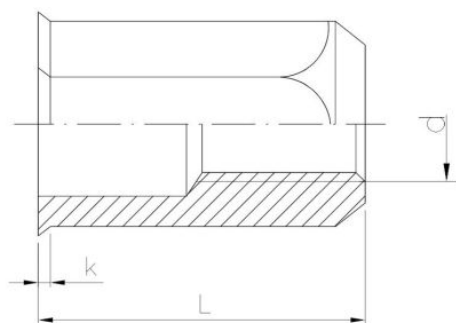

Beschichtung (Standard):

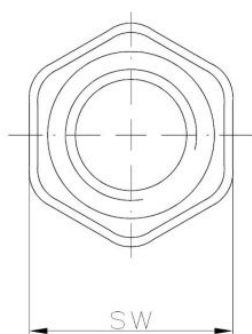

Maße

Material index	d	L [mm]	k [mm]	sw [mm]	s [mm]
2514040110ST6KT	M4	11.0	0.50	5.9	0.5-2.5
2514080185ST6KT	M8	18.5	0.65	10.9	1.0-4.0
2514060160ST6KT	M6	16.0	0.60	8.9	1.0-3.5
2514050145ST6KT	M5	14.5	0.50	6.9	0.5-3.0