

**Standards:**

DIN 571  
PN-M 82501~

Beschichtung (Standard):

**B**  
WEISS  
VERZINKT

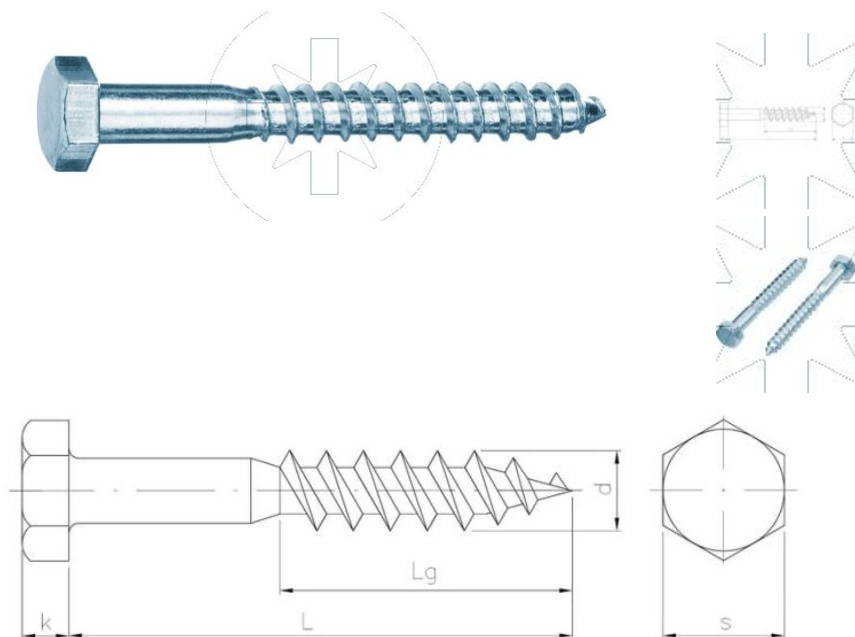

**Maße**

Material index	d [mm]	L [mm]	s [mm]	k [mm]	Art der Beschichtung
3203060090BPRK	6.0	90	10.0	4.0	B (Weiss verzinkt)
3203080090BPRK	8.0	90	13.0	5.3	B (Weiss verzinkt)
3203100080BPRK	10.0	80	17.0	6.8	B (Weiss verzinkt)
3203060080BPRK	6.0	80	10.0	4.0	B (Weiss verzinkt)
3203120080BPRK	12.0	80	19.0	8.0	B (Weiss verzinkt)
3203080080BPRK	8.0	80	13.0	5.3	B (Weiss verzinkt)
3203080070BPRK	8.0	70	13.0	5.3	B (Weiss verzinkt)
3203060070BPRK	6.0	70	10.0	4.0	B (Weiss verzinkt)
3203060060BPRK	6.0	60	10.0	4.0	B (Weiss verzinkt)
3203080060BPRK	8.0	60	13.0	5.3	B (Weiss verzinkt)
3203100060BPRK	10.0	60	17.0	6.8	B (Weiss verzinkt)
3203060050BPRK	6.0	50	10.0	4.0	B (Weiss verzinkt)
3203080050BPRK	8.0	50	13.0	5.3	B (Weiss verzinkt)
3203100040BPRK	12.0	40	17.0	8.0	B (Weiss verzinkt)
3203060040BPRK	6.0	40	10.0	4.0	B (Weiss verzinkt)
3203080040BPRK	8.0	40	13.0	5.3	B (Weiss verzinkt)
3203100300BPRK	10.0	300	17.0	6.8	B (Weiss verzinkt)
3203120300BPRK	12.0	300	19.0	8.0	B (Weiss verzinkt)
3203080030BPRK	8.0	30	13.0	5.3	B (Weiss verzinkt)
3203080260BPRK	8.0	260	13.0	5.3	B (Weiss verzinkt)

<b>Material index</b>	<b>d [mm]</b>	<b>L [mm]</b>	<b>s [mm]</b>	<b>k [mm]</b>	<b>Art der Beschichtung</b>
3203120260BPRK	12.0	260	19.0	8.0	B (Weiss verzinkt)
3203100260BPRK	10.0	260	17.0	6.8	B (Weiss verzinkt)
3203120240BPRK	12.0	240	19.0	8.0	B (Weiss verzinkt)
3203100240BPRK	10.0	240	17.0	6.8	B (Weiss verzinkt)
3203120220BPRK	12.0	220	19.0	8.0	B (Weiss verzinkt)
3203100220BPRK	10.0	220	17.0	6.8	B (Weiss verzinkt)
3203080200BPRK	8.0	200	13.0	5.3	B (Weiss verzinkt)
3203100200BPRK	10.0	200	17.0	6.8	B (Weiss verzinkt)
3203120200BPRK	12.0	200	19.0	8.0	B (Weiss verzinkt)
3203080180BPRK	8.0	180	13.0	5.3	B (Weiss verzinkt)
3203100180BPRK	10.0	180	17.0	6.8	B (Weiss verzinkt)
3203120180BPRK	12.0	180	19.0	8.0	B (Weiss verzinkt)
3203080160BPRK	8.0	160	13.0	5.3	B (Weiss verzinkt)
3203100160BPRK	10.0	160	17.0	6.8	B (Weiss verzinkt)
3203120160BPRK	12.0	160	19.0	8.0	B (Weiss verzinkt)
3203060140BPRK	6.0	140	10.0	4.0	B (Weiss verzinkt)
3203100140BPRK	10.0	140	17.0	6.8	B (Weiss verzinkt)
3203120140BPRK	12.0	140	19.0	8.0	B (Weiss verzinkt)
3203080140BPRK	8.0	140	13.0	5.3	B (Weiss verzinkt)
3203100120BPRK	10.0	120	17.0	6.8	B (Weiss verzinkt)
3203120120BPRK	12.0	120	19.0	8.0	B (Weiss verzinkt)
3203080120BPRK	8.0	120	13.0	5.3	B (Weiss verzinkt)
3203060120BPRK	6.0	120	10.0	4.0	B (Weiss verzinkt)
3203080100BPRK	8.0	100	13.0	5.3	B (Weiss verzinkt)
3203120100BPRK	12.0	100	19.0	8.0	B (Weiss verzinkt)
3203100100BPRK	10.0	100	17.0	6.8	B (Weiss verzinkt)
3203060100BPRK	6.0	100	10.0	4.0	B (Weiss verzinkt)