

Beschichtung (Standard):

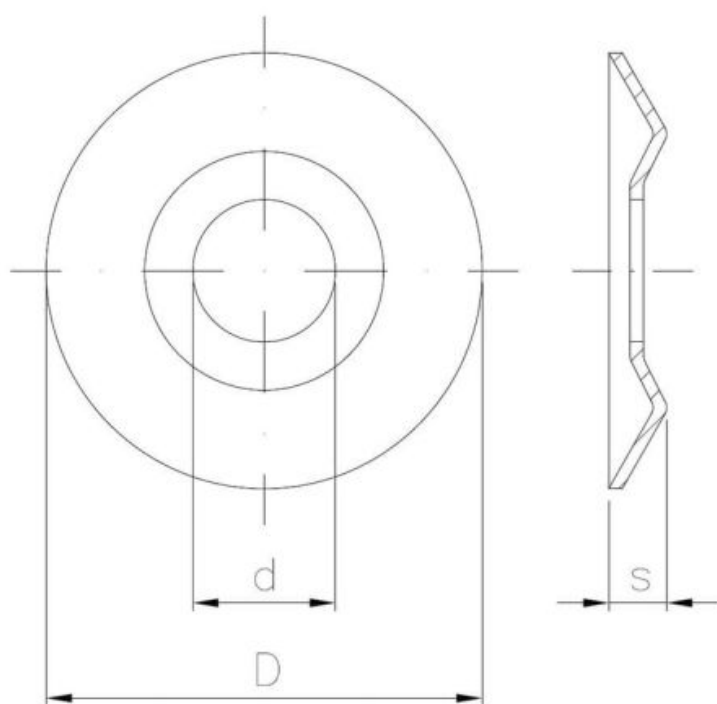

Maße

Material index	d [mm]	D [mm]	s [mm]	Art der Beschichtung
1409BMIST	6	15	4.0	B (Weiss verzinkt)
1409AMIST	6	15	4.0	B (Weiss verzinkt)
1409040130BMIST	4	13	3.0	B (Weiss verzinkt)