

ANFRAGE

+48 58 55 40 410

Standards:

DIN 766~

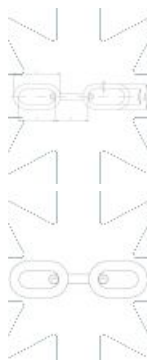
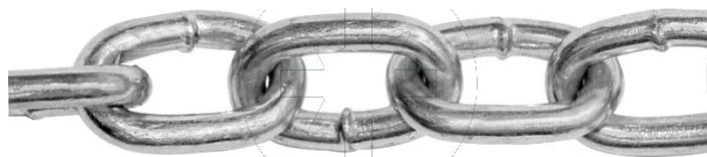

Beschichtung (Standard):

Materiale:

B
POWLOKA
CYNKOWA
BIELA

A4

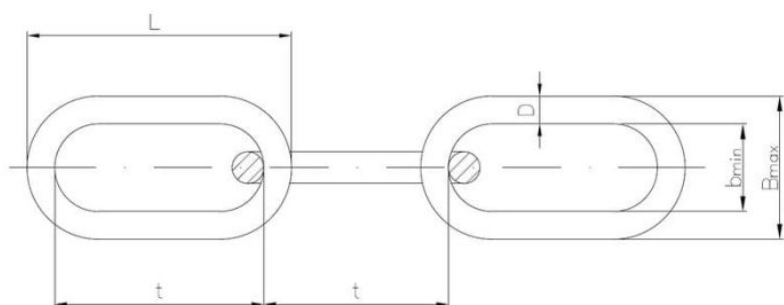

Maße

Material index	D [mm]	L [mm]	P [mm]	B1 [mm]	Bmax [mm]	Obciążenie znamionowe [kg]	Obciążenie zrywające [kg]
I6305040A4766M	4.0	27.0	16.0	4.8	13.6	500	800
I6305030A4766M	3.0	22.0	16.0	5.5	11.0	280	440
I6305080A4766M	8.0	48.0	24.0	9.6	27.2	2000	3200
I6305020A4766M	2.0	16.0	12.0	3.5	8.0	125	200
I6305060A4766M	6.0	36.0	18.5	7.2	20.4	1000	1600
I6305050A4766M	5.0	31.0	18.5	6.0	17.0	800	1250